

NAME:

ECOWall

DESCRIPTION:

Thermobonded sound-absorbing monomateric panel

APPLICATIONS:

- Wall with velcro or magnets
- Ceiling with velcro or magnets
- Suspended ceiling with cable

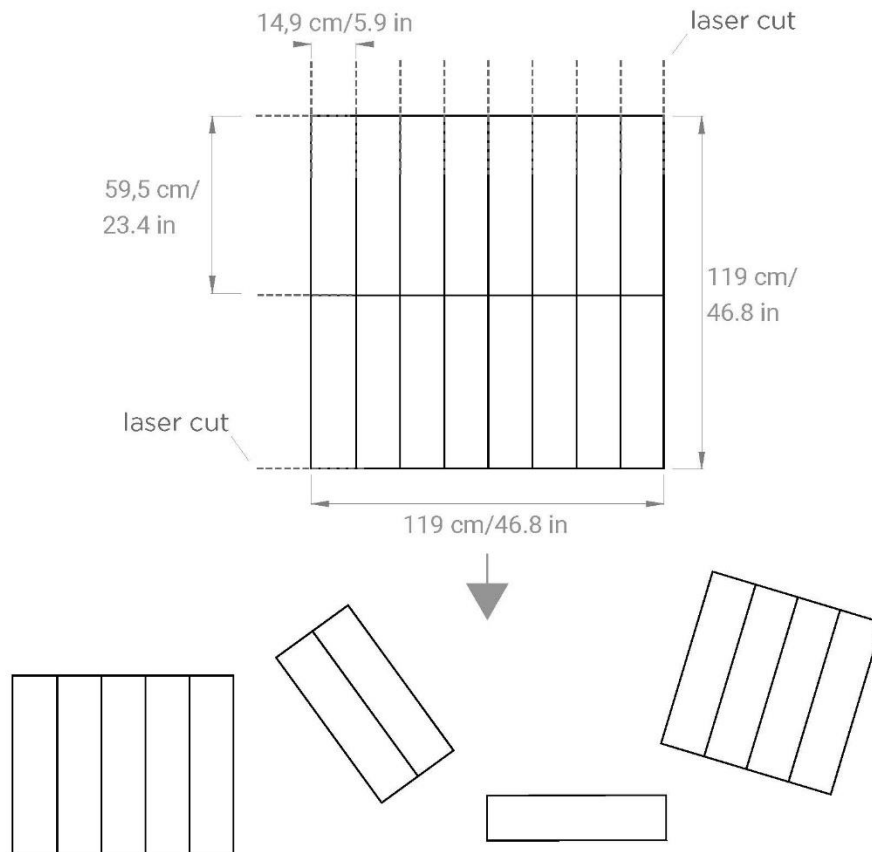

DIMENSIONS:

- L 14,9 | 29,8 | 44,7 | 59,5 | 119 x H 14,9 | 29,8 | 44,7 | 59,5 | 119 x THK 2 cm
- L 5.9 | 11.7 | 17.6 | 23.4 | 46.8 x H 5.9 | 11.7 | 17.6 | 23.4 | 46.8 x THK 0.79 in

NOTE: *Panels may have differences in thickness due to the type of material*

WEIGHT:

- 2,9 kg/m²
- 0.59 lb/ft²

COMPOSITION:

- **Soul:** sound absorbing material made of 100% recycled material, polyester fibers

Reaction to fire: B-s2, d0

Smoke class: F1

Certificate: Oekotex

- **Finiture CAT A:**

- **Trevira CS** - 100% Trevira CS FR, poliestere Fr

Reazione al fuoco: **Class 1**

Certificato: **Oekotex**

- **PETfabric** - 100% poliestere FR riciclato + GRS

Reazione al fuoco: **Class 1**

Certificato: **Oekotex**

- **PETcolor** - 100% PET, poliestere FR riciclato + GRS

Reazione al fuoco: **Class 1**

- **ECOfelt** - 90% lana naturale, 10% poliestere

- **PETfelt** - 96% PET - Bottiglie di plastica postconsumo

- **Velvet** - 100% poliestere

- **Finiture CAT B:**

- **Tweed** - 75% lana, 25% poliammide

Reazione al fuoco: **Class 1**

- **Trace** - 100% Trevira CS FR, poliestere Fr

Reazione al fuoco: **Class 1**

Certificato: **Oekotex**

RECYCLABILITY:

Recyclable material panel recyclable at the end of his life, without having to divide soul and finishing

MAINTENANCE:

Cleanable panel with specific detergents

CERTIFICATIONS:

• **FIRE REACTION CLASS:**

B-s2, d0



• **GREEN LABELS:**

GREENGUARD
GREENGUARDGOLD



VOC EMISSION TEST Indoor Air Comfort GOLD



• **SOUND ABSORPTION REPORT:**

UNI EN ISO 354: 2003
UNI EN ISO 11654: 1998



ECOWALL:

RISULTATI SPERIMENTALI / TEST RESULTS

Elemento in prova / Tested element **ECOWall**

Superficie del campione S = **10,80 m²**
Sample surface

FREQ (Hz)	T1 (sec)	T2 (sec)	α_s	α_p
100	6,17	3,18	0,44	
125	5,59	3,12	0,40	0,45
160	6,21	3,11	0,46	
200	5,75	2,70	0,56	
250	5,65	2,78	0,52	0,60
315	5,62	2,42	0,67	
400	5,75	2,40	0,70	
500	5,64	2,44	0,67	0,65
630	5,39	2,40	0,66	
800	5,20	2,20	0,75	
1000	4,89	2,11	0,77	0,75
1250	4,60	2,02	0,79	
1600	4,10	1,92	0,79	
2000	3,66	1,83	0,78	0,80
2500	3,02	1,66	0,77	
3150	2,25	1,43	0,72	
4000	1,87	1,30	0,67	0,70
5000	1,39	1,05	0,66	

Valutazione secondo ISO 11654
Rating according to ISO 11654
 $\alpha_w = 0,75$

NRC = 0,70

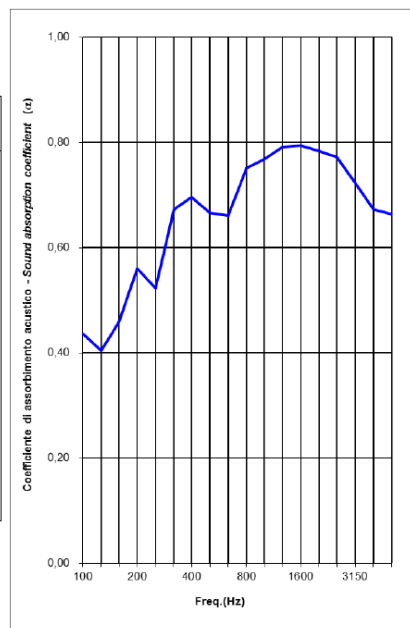

THICKNESS
gr / mtl 460 ± 10%

WIDTH
cm 140 ± 2% | " 55 ± 2%



Trevira CS.

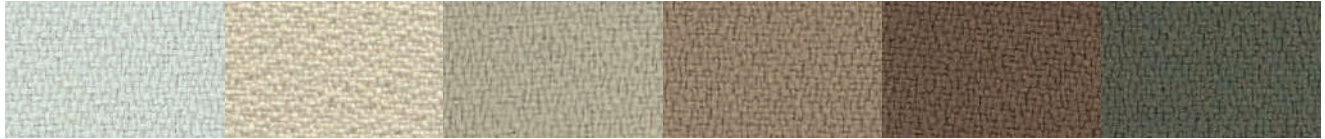

Light grey 611T Moka 516 Beige 532 Camel 533 Tuscan brown 534 Brown sugar 569

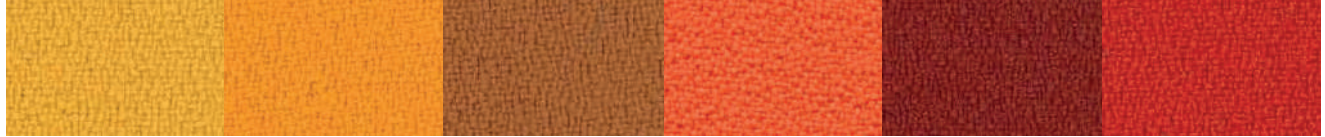

Yellow 53 Carrot 66 Tiger eye 119 Summer 133 Brick 572 Orange 120

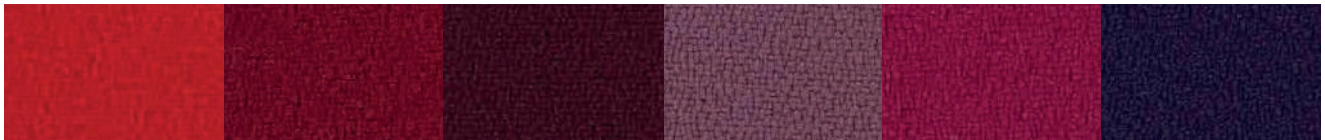

Red 231 Bordeaux 236 Red wine 234 Lavender 175 Fuchsia 173 Purple 262

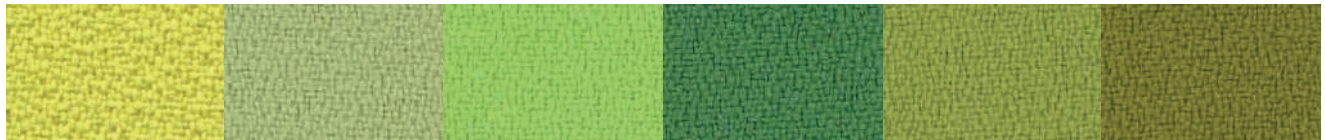

Lime 462 Green tea 425 Apple Green 463 Office green 443 Grass 464 Olive 426

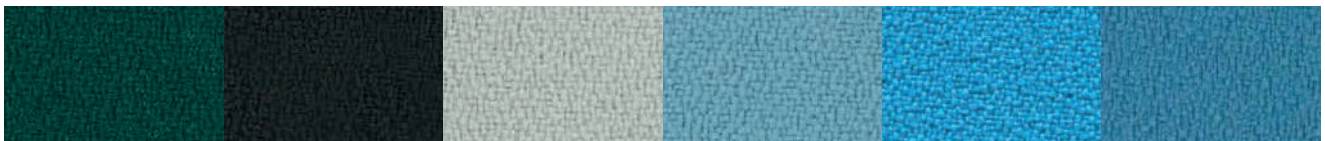

Forest green 496 Dark mud 571 Pearl grey 643 Light blue 386 Azuleja 367 Capri 379

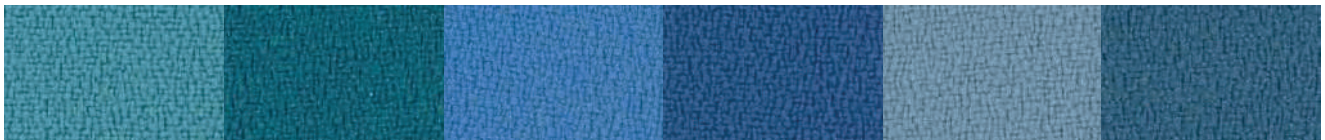

Turquoise 366 Peacock blue 411 Pastel blue 380 Steel blue 263 Iceberg 377 Queen blue 378

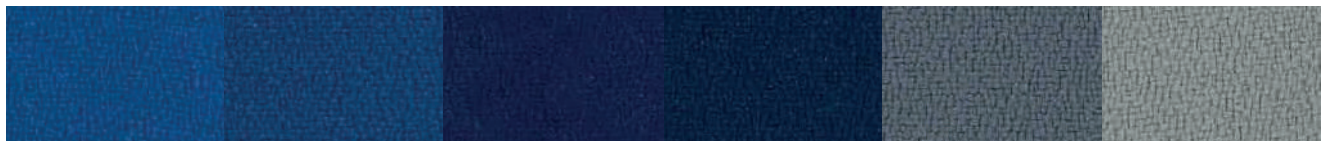

Sapphire 331 Office blue 332T Dark blue 334T Midnight blue 333T Quartz grey 636 Grey 629



Old silver 625 Taupe 607 White 999 Black 651



THICKNESS
gr / mtl 470 ± 10%

WIDTH
cm 140 ± 2% | " 55 ± 2%



PETfabric.



Jacket 4559 Warm grey 4560 Dark red 4210 Brown 4558 Sand 4513 Cream 4515



Bronze 4109 Orangina 4105 Sunset 4107 Brick 4211 Poppy 4214 Light blue 4361



Spring Morning 4153 Lilac 4253 Dark Magenta 4154 Antique Rose 4155 Ice 4365 Sky 4360

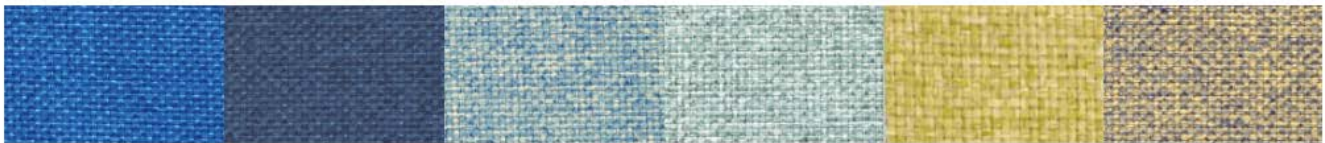

Villa 4310 Blue 4313 Azure 4311 Morning green 4467 Gold 4057 Camo 4312

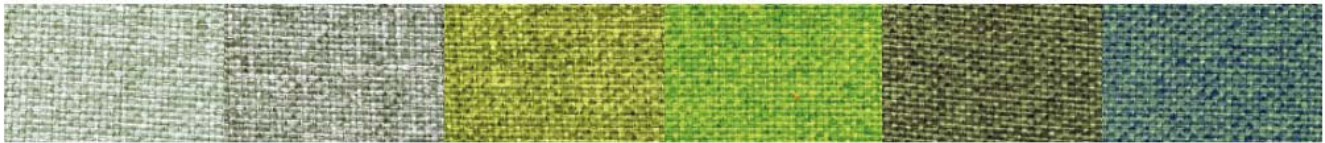

Sage 4466 Mesh green 4468 Bright green 4464 Brilliant green 4460 Underbrush 4462 Tropical 4461



Neutral grey 4511 Light grey 4613 Ash 4614 Suit grey 4615 Road 4616



THICKNESS
gr / mtl 470 ± 10%

WIDTH
cm 140 ± 2% | " 55 ± 2%



PETcolor.

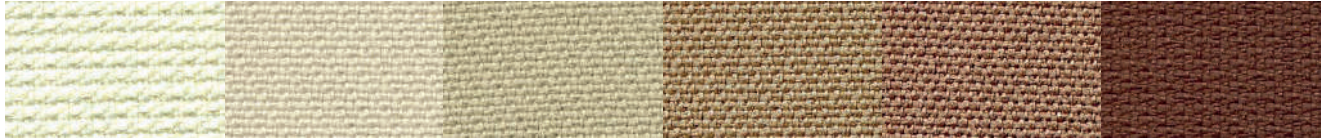

White 2999 Milk 2509 Beige 2503 Camel 2504 Deer 2510 Sierra 2557

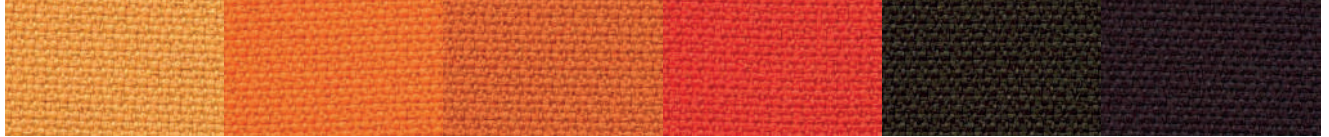

Yellow 2051 Orange 2104 Papaya 2103 Red 2201 Mud 2552 Dark chocolate 2556



Brick 2555 Palazzo red 2206 Ossalide 2151 Bordeaux 2203 Malva 2251 Blueberry 2252



Pistachio 2451 Green leaf 2452 Forest 2459 Peacock 2402 Sugar 2357 Pouder 2358



Ice 2612 Light blue 2351 Greece 2308 Van Gogh 2301 Midnight 2309 Blue romance 2303



Grey 2602 Infinity 2307 Rock Grey 2603 City grey 2604 Black 2651



THICKNESS
mm 1,5 | gr/mtl 420

WIDTH
cm 150 ± 5% | " 59 ± 5%



ECOfelt.



Ghost white 955E Chalk 327 Grey 953E Concrete 903 Ink 329 Dark grey 923



Beige 952 Caramel 332E Mushroom 325 Chocolate 352 Taupe 511 Brown 605

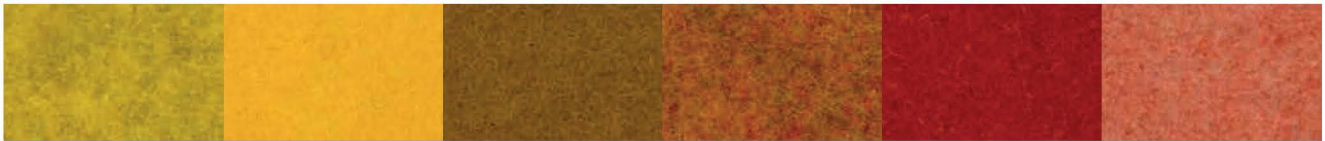

Yellow 34 Egg 980 Mustard 54 Cob orange 997 Orange 971 Salmon 317



Red 5 Rust 604 Pompei 47 Bordeaux 192 Marsala 973 Quartz rose 940



Bubble pink 53 Pink 988 Mauve 601 Agate 919 Violet 921 Purple 508



Barolo 602 Grape 603 Acid green 611E Cashmere green 89 Grassland 937 Tea Green 345



Leaf Green 910 Black forest 77 Dark musk 22E Fresh air 976 Salvia green 334E Mineral Blue 311



Lagoon 608 Peacock blue 962 Biggest Splash 41 Capri 341 Avio 333E Moonstone 512



Azuleja 318 Light blue 914 Blue yonder 200 Honolulu blue 607 Blue 193 Deep sea blue 963

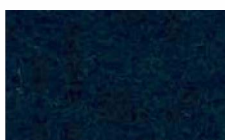

Nynph 972

THICKNESS
mm 1,5 | gr/mtl 420

WIDTH
cm 150 ± 5% | ” 59 ± 5%



PETfelt.



Ash 703 Fog 953P Milk 955P Beige 16 Tuscan brown 20 Mud 19



Pale yellow 41 Alabaster 32 Yellow 3 Duck Orange 43 Orange 9 Dark Orange 14



Red 6 Ruby red 27 Bordeaux 15 Pastel pink 37 Pink 17 Wisteria pink 36



Barbie 113 Fuchsia 10 Sangria 30 Grapes 23 Purple 11 Raspberry 47



Opal 33 Celadon 39 Water green 2 Kiwy 28 Acid green 7 La salle green 12



Jungle green 31 Grey green 22 Egg blue 38 Light blue 8 Blue 13 Azure 1



Summer night 21 Charm blue 44 Pacific blue 29 Dark blue 5 Midnight 905 Rhino 903



Grey 4 Street 529 Rich black 18



THICKNESS
gr / mtl 420

WIDTH
cm 145 ± 2% | " 57



Velvet.



Beige 104

Mauve 23V

Marsala 80



Yellow 26

Cherry 10V

Bordeaux 90



Taupe 205

Graphite 617

Brown 100



Bright green 12V

Salvia green 56

Lagoon 15V



Grey 616

Avio 16V

Deep sea blue 14V

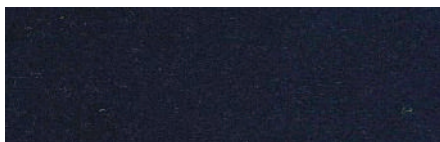

Dark blue 666

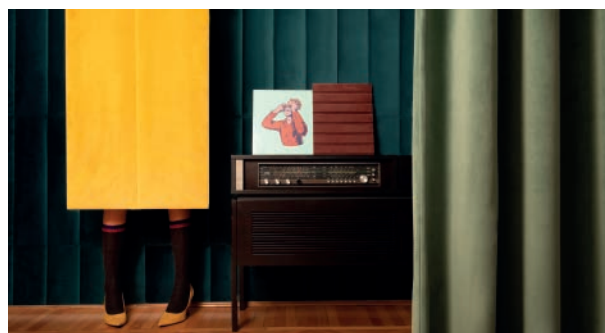

THICKNESS
gr / mtl 490 ± 10%

WIDTH
cm 140 ± 2% | " 55 ± 2%



Trace.

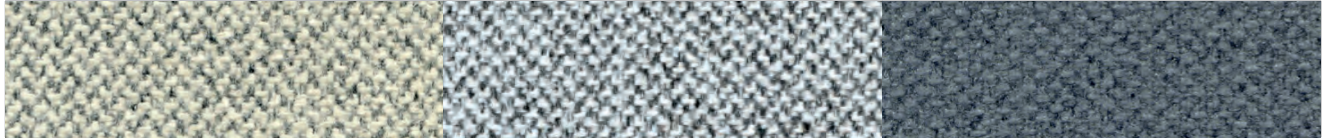

Warm grey 9607

Cold grey 9610

Formal grey 9608



Sea 9402

Blue 9302

Ocean 9403



Yellow 9052

Pistachio 9452

Green leaf 9455

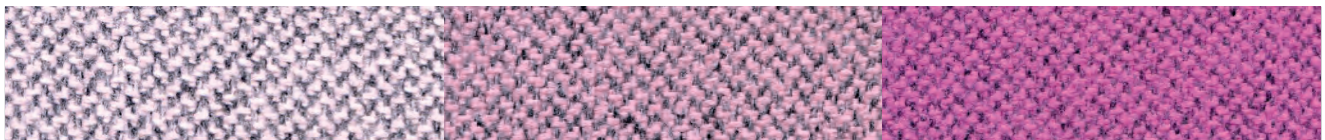

Cloud pink 9155

Pink 9154

Blossom 9156

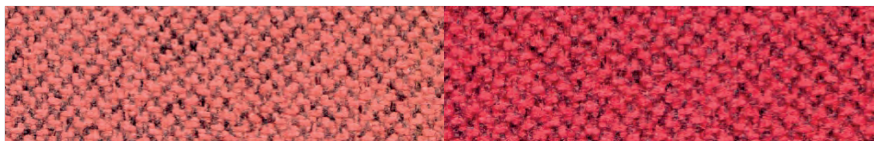

Salmon 9157

Strawberry 9203

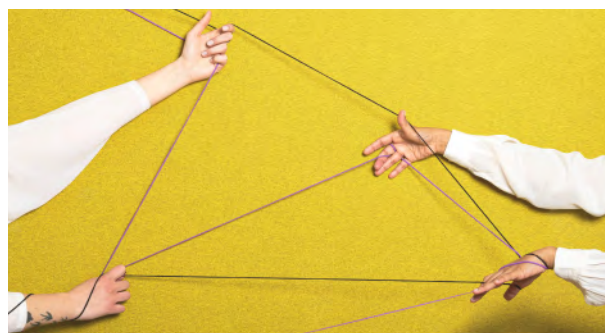

THICKNESS
gr / mtl 500 ± 7%

WIDTH
cm 150 ± 5% | ” 59 ± 5%



Tweed.



Almond 505

Sand 502

Rose 503

Brown 504

Coffee 551

Chestnut 552



Banana 51

Dark gold 52

Mandarin 102

Cadmium 101

Orange 2105

Terra di Siena 103



Pistachio 451

Pond 2457

Foliage 452

Racing green 453

Teal blue 454

Blue 303



Aqua green 455

Air blue 351

River 2460

Grey blue 301

Orchid 251

Purple 252

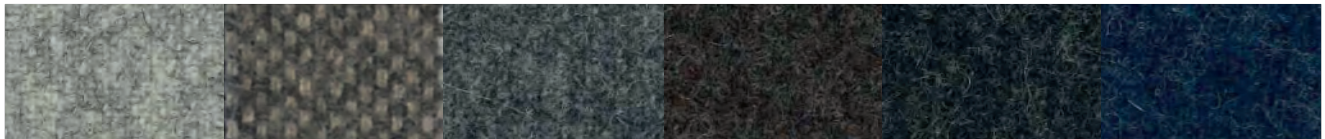

Ash grey 601

Melting grey 2606

Rock grey 602

Old brown 553

Dark grey 603

Night blue 302



Pink 152

Red 211

Antique ruby 201

Berry 202

Full black 651

